



**Authorized Dealer:**  
Global Sales Group, LLC  
P.O. Box 1835 \* Chico, CA 95927  
Toll Free: 877-474-5521  
Office: 530-893-2444  
www.globalsalesgroupllc.com



**CS-1245AAT-8 8 FT Program Double 12" Miter Saw**  
**CS-1245AAT-12 12 FT Program Double 12" Miter Saw**  
**CS-1245AAT-16 16 FT Program Double 12" Miter Saw**

**Optional:**

- AF-MAG MAGAZINE, HOPPER TABLE
- AF-OPT OPTIMIZE DEVICE (MAKER, CRAYON READER, TRACER FUNCTION)

**Features:**

- Double 45 degree miter cut off saw equipped with AF-08 auto pusher fence for added automation, efficiency and accuracy.
- 8' infeed table and 4' outfeed rollers table.
- With programmable controller, it can act as AUTO STOPS or AUTO PROGRAM SIZING PUSHER for mass production jobs.
- PLC controlled automatic pusher, fence device driven by servo motor.
- Stops: Just key in the size, it will automatically move to the position, ready for the cutting size and automatically finishes the cutting cycle.
- Pusher Fence: Just key in all the sizes and each job's quantities, it will move to the material length, after loaded, it pushes to the first size, automatically completes the cutting cycle. Then it will keep going for the quantity or the next size inputted. Continues until all the cutting has finished, and then it will automatically restart again.
- Fifty sets of job data memory, extendable: printer, PC link, and unlimited memory.
- Efficiency and accuracy for all jobs requiring sizing such as boring, drilling and cutting.

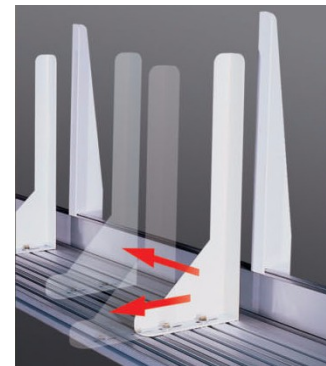

- Super traveling speed up to 200 feet per minute.
- Within 0.004" accuracy.
- Other lengths are available.
- Sealed long-life ball bearings.
- Full 3 HP x 2 motor for powerful cutting capacity.
- Precision ground cast iron table with heavy metal cabinet stands.
- Easy operation for furniture, lumber, door, pallet or other manufacturing.
- Saw blades come up from bottom of the table and returns right after cutting for safety operation.
- Magnetic control with overload protection.
- Full saw blade guard prevents any dangers during cutting cycle.

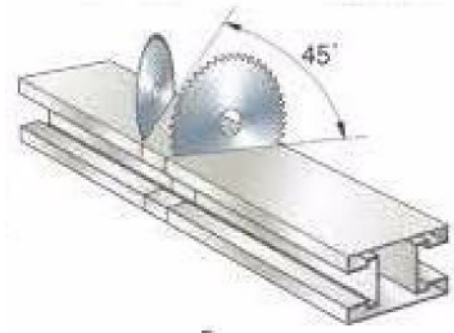

SPECIFICATIONS	CS-1245	CS-1645	CS-1845
Cutting Angle	45 Degree (Fixed)	45 Degree (Fixed)	46 Degree (Fixed)
Max. Cutting Width	3-1/8"	4-5/16"	5-1/8"
Max. Cutting Thickness	3"	4-3/4"	9-7/8"
Saw Blade Speed	3400 RPM	3050 RPM	2700 RPM
Saw Blade Size	12" x 1" Dia.	16" x 1" Dia.	18" x 1" Dia.
Cycle Speed / Min	5 ~ 10	3 ~ 7	3 ~ 6
Table Area	32" x 12"	34" x 12"	34" x 12"
Table Height	34"	32"	32"
Motor	1 HP x 2	2 HP x 2	3 HP x 2
Length of Outfeed Table	4 FT	4 FT	4 FT
N.W.	720 LBS	890 LBS	1050 LBS

(Training and installation, tooling & rigging are optional)  
 (Customer is responsible for local regulations and connecting utilities)

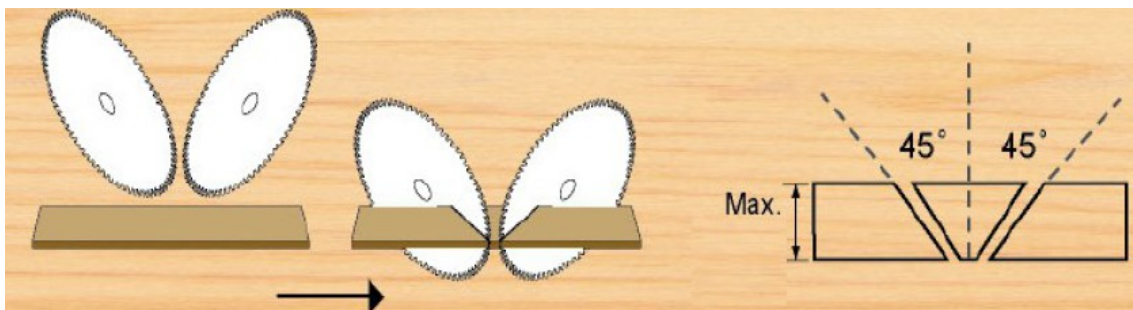
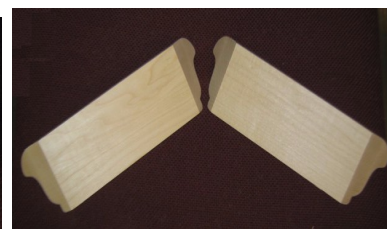
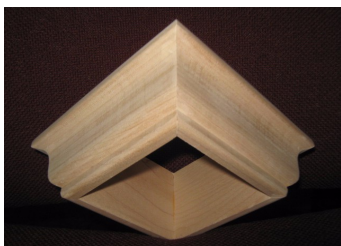

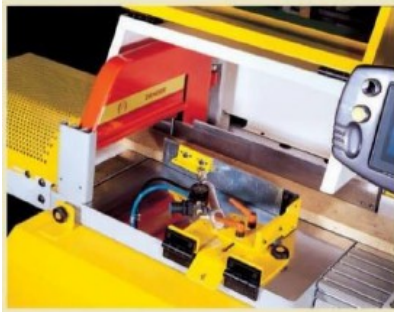

**SIDE ALIGNMENT:**  
 Special design flip able side alignment device, enable for narrow or quickly flip up for wider material without any time wasting.  
 Pneumatic alignment device to push the material against the fence for accurate cutting size.



Servomotor system the positioning devise uses the servomotor system.  
 Its advantage is fast movement and accurate positioning.

Automatic positioning system the fast moving pusher reaches a maximum distance of 60m/min with perfect positioning

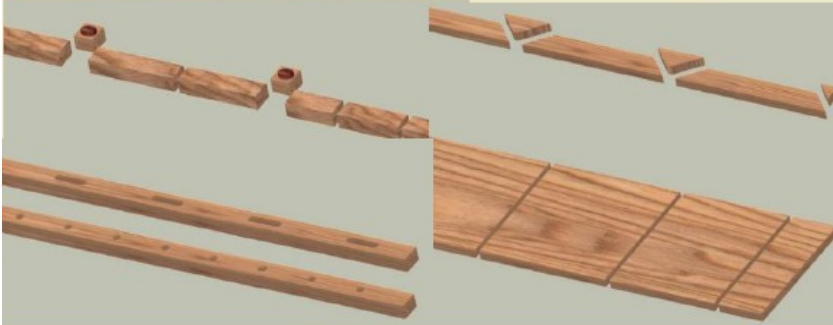

## Optional: Auto Feed Magazine



**AUTO FEED MAGAZINE:**  
 Designed for automatic hopper feeding with repeated cutting cycle by the pusher.





Touch screen the touch screen's function button allows practical understanding thus bringing out the best of this devise



## FUNCTION

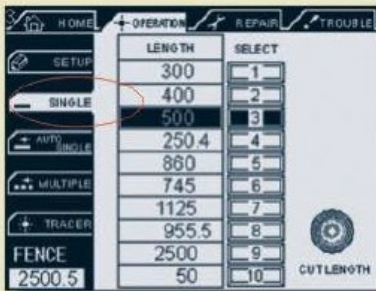

### SINGLE:

This section is acted as stopper for single size cutting. Just key in the desired size for the cutting length or choice the size from the 10 sets of memory.

### AUTO SINGLE:

This section is acted as single size with multiple cutting quantities. Key in the desired cutting length, material length and the pusher will move to the size every time for the auto cutting cycle.



### MULTIPLE:

This section is acted as multiple sizes and multiple quantities by automatic cutting cycle. Key in the material length, trim size, desired cutting size and quantity. The program will show the length of remain material automatically. 50 set memory with each of 10 sets of cutting length and quantity.



- . PLC controlled automatic fence device driven by servomotor active as:
- . STOP: Just key in the size, it will automatic moved to the position, ready for the job size.
- . Push FENCE: Just key in all the sizes and quantities, it will move to the length then push to the first size. When the job finished, it will keepgoing for the quantity or the next size inputted continued until all the setting was finished, it will restart again.
- . Standard eight sets of job data memory. Extendable: printer, PC link, and unlimited memory.
- . Efficiency and Accuracy for all the jobs require sizing such boring, drilling and cutting .
- . Super traveling speed up to 200 feet per minute.
- . Within +-0.10mm accuracy.
- . Other lengths are available.



### Optional equipment Auto tracer

a fluorescent pen is used to mark off unwanted marks on the material which is later cut off with the aid of a sensor.

This section is acted as auto defect cutting program. To use the fluorescent crayon marked the front & back of defect parts for cutting line.



This section It can also to set one desire d cutting size between the defect parts automatically

